

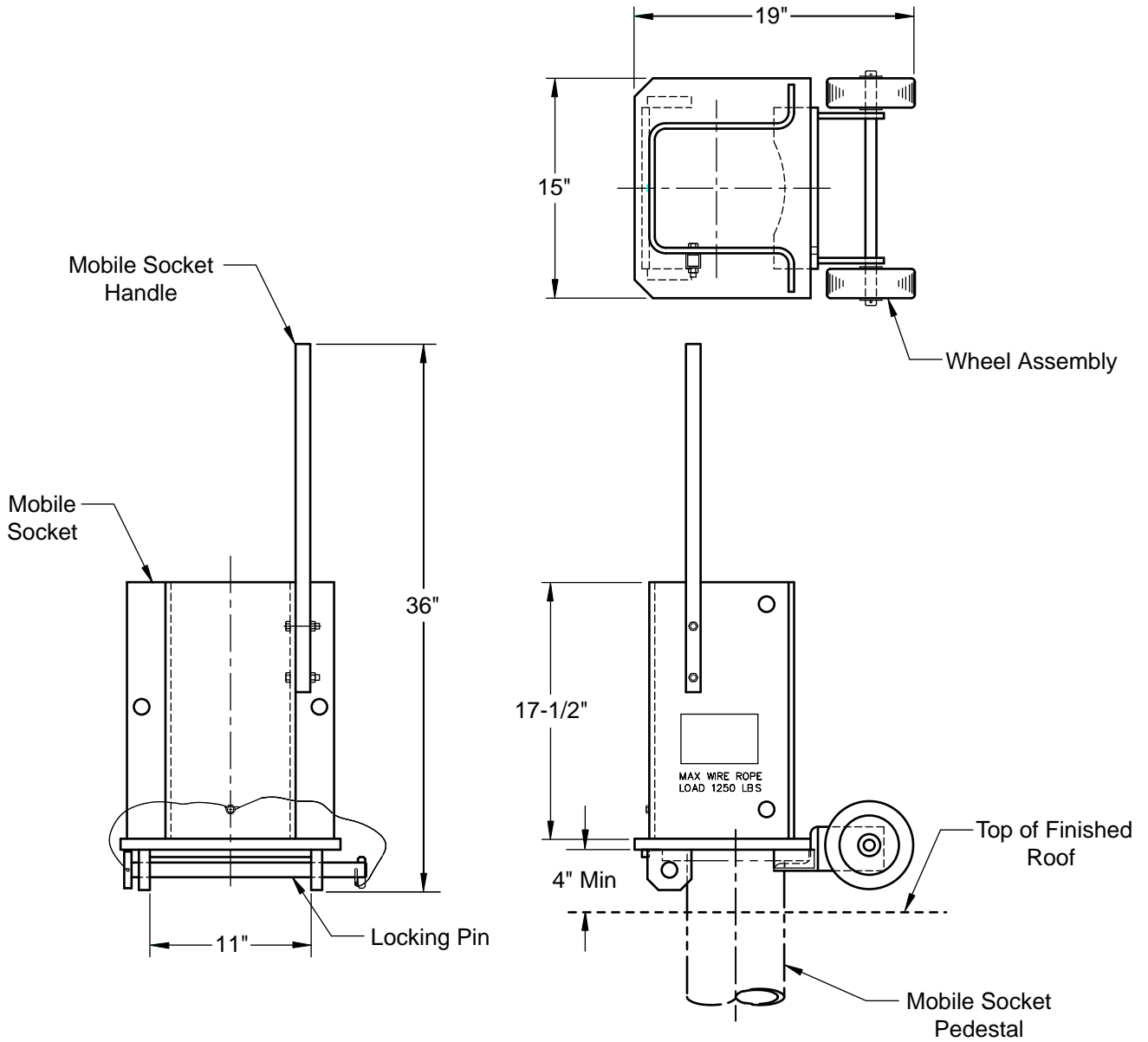

DATA & SPECIFICATION SHEET
5" 1250 LB MOBILE SOCKET - 4143



Description:

The Spider 4143 Mobile socket assembly consists of a vertical formed socket, bottom plate, wheel assembly and locking pin all fabricated from steel with a galvanized finish per ASTM A123. See Application Sheets for typical mobile socket applications. Conforms to OSHA standards.

Spider Permanent Installations
 365 Upland Drive
 Tukwila, WA 98188 USA

Phone: (206) 575-6445 / Fax: (206) 575-6240
 E-mail: spiderpi@safeworks.com
 Internet: www.SpiderStaging.com/pi

D3-1-1