

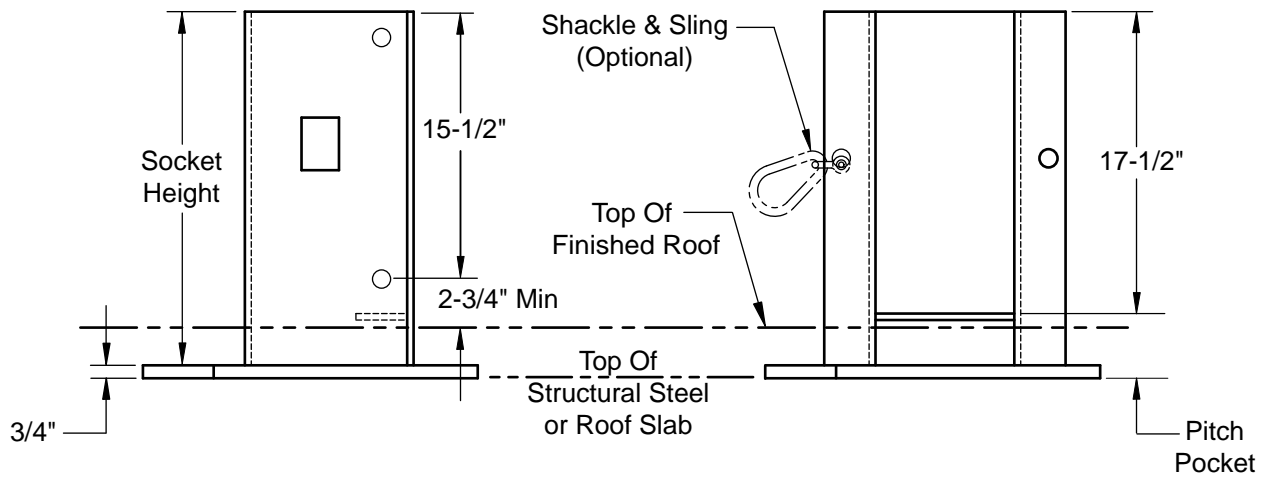

DATA & SPECIFICATION SHEET
5" BOLTED 1000 LB DAVIT SOCKET - 700879

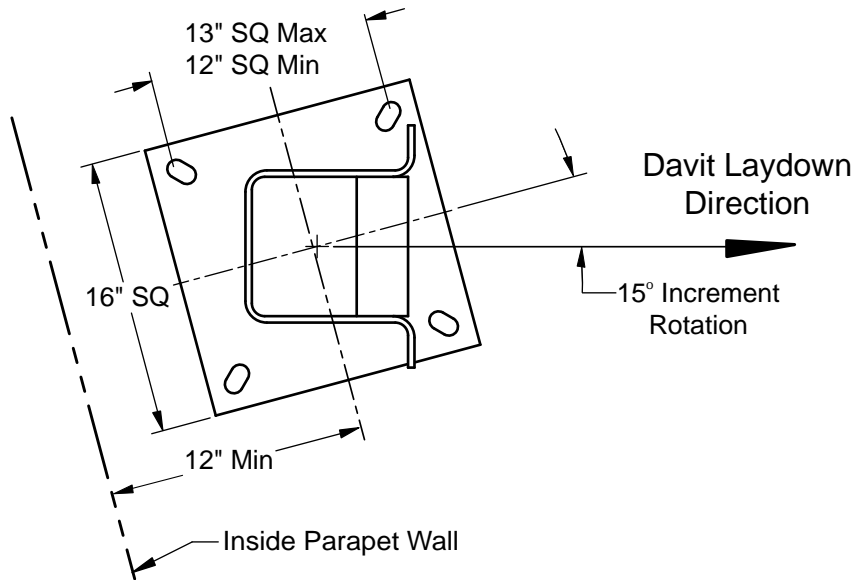

Description:

The Spider 700879 Davit socket assembly consists of a vertical formed socket, bottom plate and middle support bar all fabricated from ASTM A36 steel with a fully galvanized finish per ASTM A123. See Application Sheets for socket system applications. Conforms to OSHA standards.

Spider Permanent Installations
 365 Upland Drive
 Tukwila, WA 98188 USA

Phone: (206) 575-6445 / Fax: (206) 575-6240
 E-mail: spiderpi@safeworks.com
 Internet: www.SpiderStaging.com/pi

D2-4-1